

Inductive sensor NBN3-F31-E8-V16-V15

- Direct mounting on standard actuators
- Fixed setting

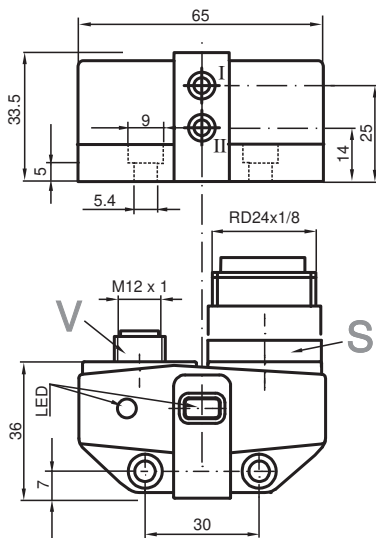

Dimensions



Technical Data

General specifications

Switching function		2 x normally open (NO)
Output type		PNP
Rated operating distance	s_n	3 mm
Installation		flush mountable
Output polarity		DC
Assured operating distance	s_a	0 ... 2.43 mm
Reduction factor r_{AI}		0.5
Reduction factor r_{304}		1
Reduction factor r_{St37}		1.2
Output type		3-wire

Nominal ratings

Operating voltage	U_B	10 ... 30 V DC
Switching frequency	f	0 ... 500 Hz

Release date: 2022-05-30 Date of issue: 2022-05-30 Filename: 192482_eng.pdf

Refer to "General Notes Relating to Pepperl+Fuchs Product Information".

Pepperl+Fuchs Group
www.pepperl-fuchs.com

USA: +1 330 486 0001
fa-info@us.pepperl-fuchs.com

Germany: +49 621 776 1111
fa-info@de.pepperl-fuchs.com

Singapore: +65 6779 9091
fa-info@sg.pepperl-fuchs.com

 PEPPERL+FUCHS







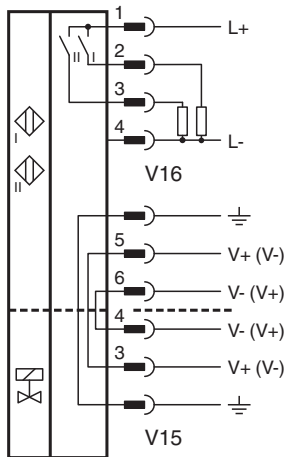



Technical Data

Hysteresis	H	typ. 5 %
Reverse polarity protection		all connections
Short-circuit protection		pulsing
Voltage drop	U_d	≤ 3 V
Operating current	I_L	0 ... 100 mA
Off-state current	I_r	0 ... 0.5 mA typ. 0.1 μ A at 25 °C
No-load supply current	I_o	≤ 25 mA
Operating voltage indicator		LED, green
Switching state indicator		LED, yellow
Functional safety related parameters		
MTTF _d		780 a
Mission Time (T _M)		20 a
Diagnostic Coverage (DC)		0 %
Valve circuit		
Voltage		max. 32 V DC
Current		max. 240 mA
Short-circuit protection		no
Reverse polarity protection		yes, with reversed output LED is out of function, therefore more power for solenoid valve
Compliance with standards and directives		
Standard conformity		
Standards		EN 60947-5-2:2007 EN 60947-5-2/A1:2012 IEC 60947-5-2:2007 IEC 60947-5-2 AMD 1:2012
Approvals and certificates		
UL approval		cULus Listed, General Purpose
CSA approval		cCSAus Listed, General Purpose
CCC approval		CCC approval / marking not required for products rated ≤ 36 V
Ambient conditions		
Ambient temperature		-25 ... 70 °C (-13 ... 158 °F)
Mechanical specifications		
Connection (system side)		Connector plug Rd 24 x 1/8 inch 6 pin+PE
Connection (valve side)		5-pin, M12 x 1 socket
Housing material		PBT
Sensing face		PBT
Degree of protection		IP67
Tightening torque, fastening screws		4 Nm ... 5 Nm

Connection Assignment



Accessories

	BT115A	Activator for F31 series
	BT115X	Activator for F31 series
	BT65B	Activator for F31 series
	BT115B	Activator for F31 series
	V16-G	Female connector, dia. 24, 6-pin+PE, field attachable
	V16-W	Female connector, dia. 24, 6-pin+PE, field attachable
	BT65A	Activator for F31 series
	BT65X	Activator for F31 series
	V15S-G	Cable connector, M12, 5-pin, ready for assembly
	V15S-W	Male connector M12 angled A-coded 5-pin, for cable diameter 4 - 6 mm, field-attachable

Release date: 2022-05-30 Date of issue: 2022-05-30 Filename: 192482_eng.pdf